

- Low glare deep reflector COB downlight.
- Remote flicker free driver with dimming & control options available.
- Reflector available in either matt or specular finish.

Product Information

Part Number	DLB190-70W
Delivered Lumens +/-5%	6370lm
Power	70W
UGR	<17
IP Rating	IP44 front face
IK Rating	n/a
IC rating	n/a
Warranty	3 Years
LED Type	COB
CCT	2.7/3/4/5K/6K CCT
CRI	90
Beam Angle	25°, 32°, 45° and 50°
Colour Stability (SDCM)	3 step Macadam Ellipse
Led Rated Lifetime L70 @25°	>50000hrs
Driver	Remote
Mains Supply	220-240V, 50/60Hz
Driver output Voltage	DC50V
Power Factor	0.09
LED Current (nominal)	1700mA
Operating Temperature	0-40°C
Body Material	Aluminium
Diffuser Material	Polycarbonate
Product Finish	Powder coated
Colours	White, Black
Total Weight	0.72kg

Dimensions

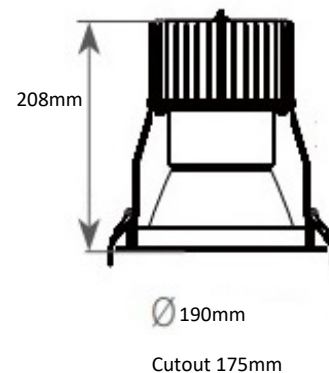

Size range from 170-280mm diameter

