

- Compact low glare COB down light.
- Remote flicker free driver with dimming & control options available.
- Several sizes in range, IP65 & adjustable versions available.

## Product Information

Part Number	DLE150-20W
Delivered Lumens +/-5%	2335lm
Power	20W
UGR	<19
IP Rating	IP20
IK Rating	n/a
IC rating	n/a
Warranty	3 Years

LED Type	COB
CCT	3/4/6K CCT
CRI	80, 90
Beam Angle	12°, 24°, 36° and 60°
Colour Stability (SDCM)	5 step Macadam Ellipse
Led Rated Lifetime L70 @25°	>50000hrs

Driver	Remote
Mains Supply	220-240V, 50/60Hz
Driver output Voltage	DC36V
Power Factor	0.09
LED Current (nominal)	500mA
Operating Temperature	0-40°C

Body Material	Aluminium
Diffuser Material	3mm toughened glass
Product Finish	Powder coated
Colours	White, Black
Total Weight	0.49kg

## Dimensions

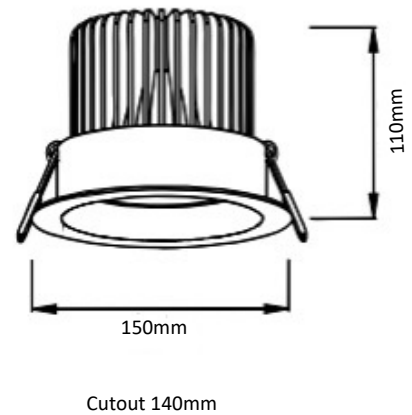

Variety of sizes, fixed or adjustable & IP65 options

