

- Perfectly suited for industrial applications & lighting large open areas.
- Optional moulded lens for assymetric light distribution.
- A variety of lenses available for different beam angles.

Product Information

Part Number	FLB50
Delivered Lumens +/-5%	6500lm 5K
Power	50W
UGR	n/a
IP Rating	IP66
IK Rating	IK08
IC rating	n/a
Warranty	3 Years

LED Type	SMD
CCT	3/4/5K
CRI	70
Beam Angle	25°, 50°, 90° and 120°
Colour Stability (SDCM)	5 step Macadam Ellipse
Led Rated Lifetime L70 @25°	>100000hrs

Driver	Integral
Mains Supply	220-240V, 50/60Hz
Driver output Voltage	DC28-56V
Power Factor	0.09
LED Current (nominal)	570mA
Operating Temperature	0-40°C

Body Material	Aluminium
Diffuser Material	Toughened glass
Product Finish	Powder coated
Colours	Black
Total Weight	2.2kg

Dimensions

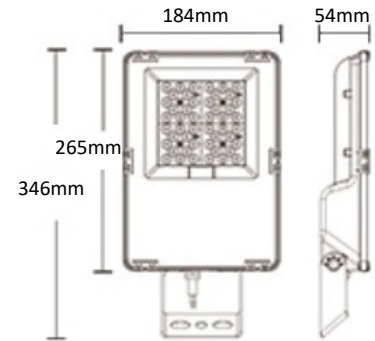

TGIC powder coating to suit tough outdoor environments

