



- Low glare COB down light with spectral reflector.
- Remote flicker free driver with dimming & control options available.
- Full range of sizes and options available in product family.

Product Information

Part Number	DLO110-10W
Delivered Lumens +/-5%	1120lm
Power	10W
UGR	<19
IP Rating	IP54 front face
IK Rating	n/a
IC rating	n/a
Warranty	3 Years

LED Type	COB
CCT	3/4/5K CCT select
CRI	80, 90, 97
Beam Angle	24°, 36° and 60°
Colour Stability (SDCM)	5 step Macadam Ellipse
Led Rated Lifetime L70 @25°	>50000hrs

Driver	Remote
Mains Supply	220-240V, 50/60Hz
Driver output Voltage	DC23-40V
Power Factor	0.09
LED Current (nominal)	230mA
Operating Temperature	0-40°C

Body Material	Aluminium
Diffuser Material	Polycarbonate
Product Finish	Powder coated
Colours	White, Black
Total Weight	0.27kg

Dimensions

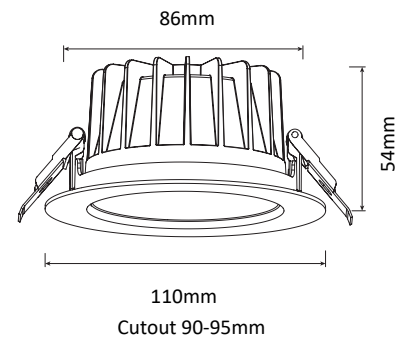

Reflector Options



Bright silver
reflector UGR19



Matt silver
reflector UGR25



White reflector
UGR25



Black reflector
UGR25